ChemPID

ChemPID: A Tikz-based PID drawer for \LaTeX

Written by
Roel Raike
Casper Janssen

Contents

1	Introduction	4
2	Anchors	5
3	Accessing options	5
4	Assets	6
4.1	Valves	6
4.1.1	Anchors	6
4.1.2	Options	6
4.2	Round heat exchanger	6
4.2.1	Anchors	6
4.2.2	Options	7
4.3	Rectangular heat exchanger	7
4.3.1	Anchors	7
4.3.2	Options	7
4.4	Columns	7
4.4.1	Anchors	7
4.4.2	Options	8
4.5	Pumps	8
4.5.1	Anchors	8
4.5.2	Options	8
4.6	Compressors	9
4.6.1	Anchors	9
4.6.2	Options	9
4.7	Separators	9
4.7.1	Anchors	9
4.7.2	Options	10
4.8	Tanks	10
4.8.1	Anchors	10
4.8.2	Options	11
4.9	Crushers	12
4.9.1	Anchors	12
4.9.2	Options	12
4.10	Mills	13
4.10.1	Anchors	13
4.10.2	Options	13
4.11	Press	13
4.11.1	Anchors	13
4.11.2	Options	13
4.12	Cooling towers	14
4.12.1	Anchors	14
4.12.2	Options	14
4.13	Driers	14
4.13.1	Anchors	14
4.13.2	Options	14

4.14	Gas filters	15
4.14.1	Anchors	15
4.14.2	Options	15
4.15	Liquid filters	15
4.15.1	Anchors	15
4.15.2	Options	15
4.16	Fittings	16
4.16.1	Viewing glass	16
4.16.1.1	Base	16
4.16.1.2	Options	16
4.16.2	Silencer	16
4.16.3	Compensator	17
4.16.4	Strainer	17
4.16.4.1	Base	17
4.16.4.2	Options	17
4.16.5	Disc	17
4.16.5.1	Base	17
4.16.5.2	Options	17
4.16.6	Vent	18
4.16.7	Funnel	18
4.16.8	Steam trap	18
4.16.9	Reducer	18
4.16.10	Flange	19
4.16.11	Connection	19
4.16.11.1	Base	19
4.16.11.2	Options	19
4.16.12	Hose	19
5	Examples	20
5.1	Distillation column with bubble caps	20
5.2	Tank	22

1 Introduction

Welcome to this humble LaTeX package that allows you to draw Piping & Instrumentation Diagrams (P&ID) or block diagrams quickly and efficiently. It contains pre-built assets in pgf to create P&ID drawings. We noticed that, with the diminishing compile time on Overleaf, it became increasingly difficult to use TikZ to this end. Therefore, we chose for pgf because it is faster to compile than TikZ objects. The objects themselves have been made in accordance with the ISO 10628-2 standard.

We worked long and hard to bring this to you and we really hope that it helps your in you endeavors! If you would have any remarks or questions, then please do reach out!

2 Anchors

The anchors are possibly the most important part of these figures since they allow you to connect these figures to the rest of your drawing. Therefore, we have tried to make the anchors as consistent as possible in terms of naming. The most common abbreviations for anchors that you will find in Section 4 are the following:

Abbreviation	Anchor name	Abbreviation	Anchor name
N	north	S	south
nN	near north	nS	near south
fN	far north	fS	far south
E	east	W	west
nE	near east	nW	near west
fE	far east	fW	far west
NE	northeast	SE	southeast
nNE	near northeast	nSE	near southeast
fNE	far northeast	fSE	far southeast
NW	northwest	SW	southwest
nNW	near northwest	nSW	near southwest
fNW	far northwest	fSW	far southwest

Most assets will only use (a selection of) these anchors. **Not every anchor is defined for every asset. Please check the section of the asset to see which are defined for that asset.** If it uses more than these, they are specified in the section of that asset, e.g. Tanks.

3 Accessing options

Accessing options is facilitated through pgfkeys, which makes them snappy. The keys though which to access them are the names of the assets, with the exception of the dish tank which uses the tank options. An example makes this much more clear. **Note that these commands exist within a tikzpicture environment.**

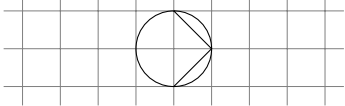
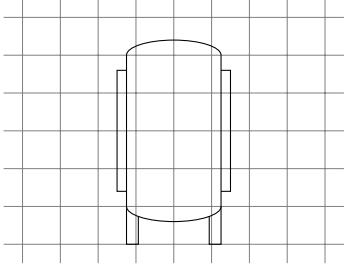
	<code>\node[pump, /pump = reciprocating]</code>
	<code>\node[dished tank, /tank = legs, /tank = jacket]</code>

4 Assets

4.1 Valves

4.1.1 Anchors

A valve is one of the cornerstones of a flowsheet or P&ID. The base asset for a valve in this package is only half of a two-way valve to allow for maximal flexibility.

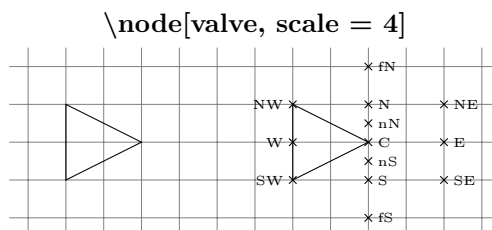

4.1.2 Options

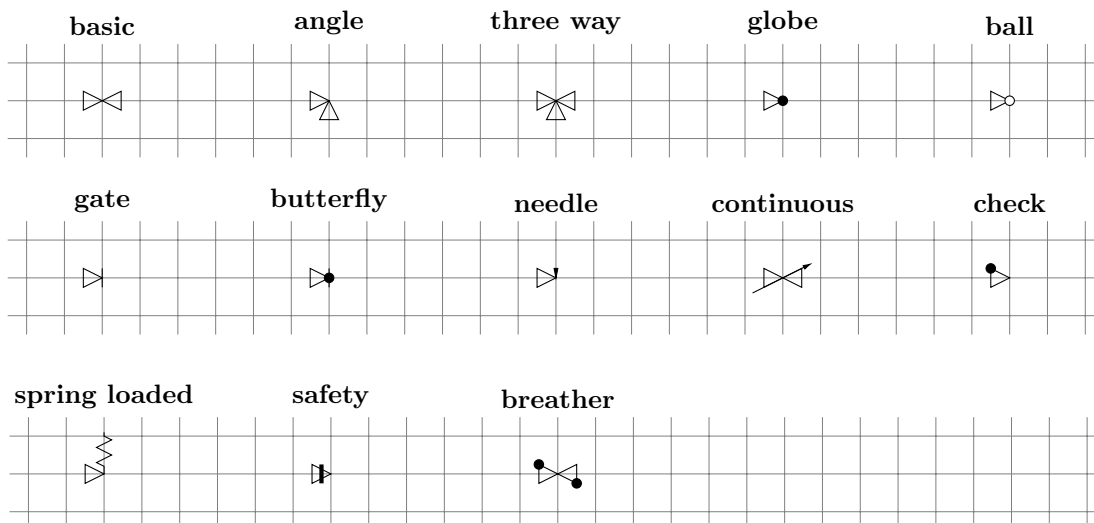

4.2 Round heat exchanger

4.2.1 Anchors

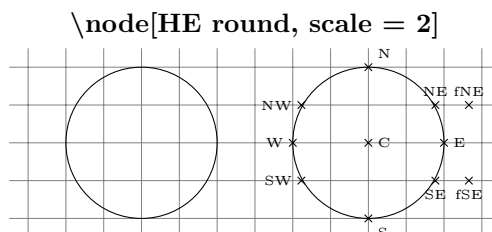

4.2.2 Options



4.3 Rectangular heat exchanger

4.3.1 Anchors

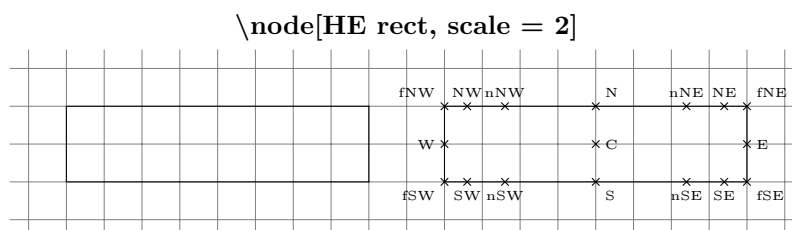

4.3.2 Options

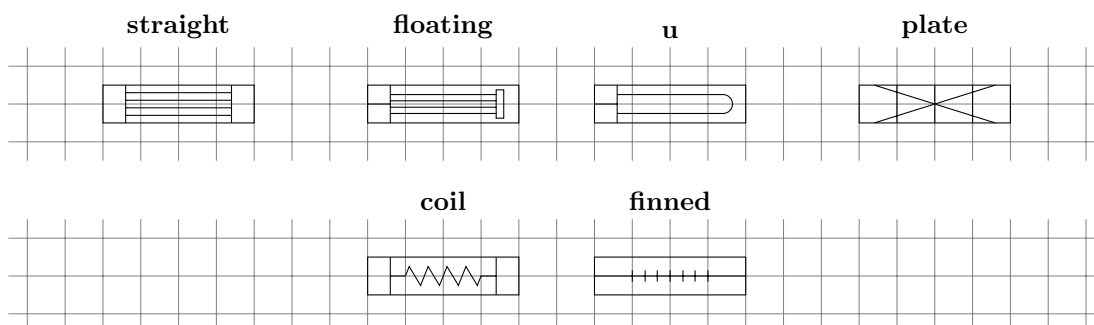

4.4 Columns

4.4.1 Anchors

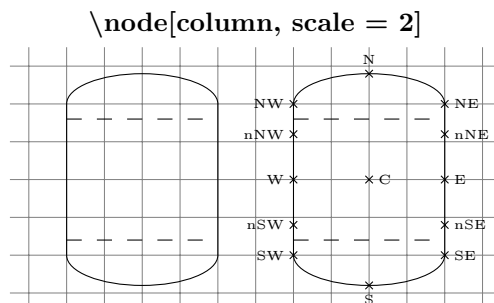

4.4.2 Options

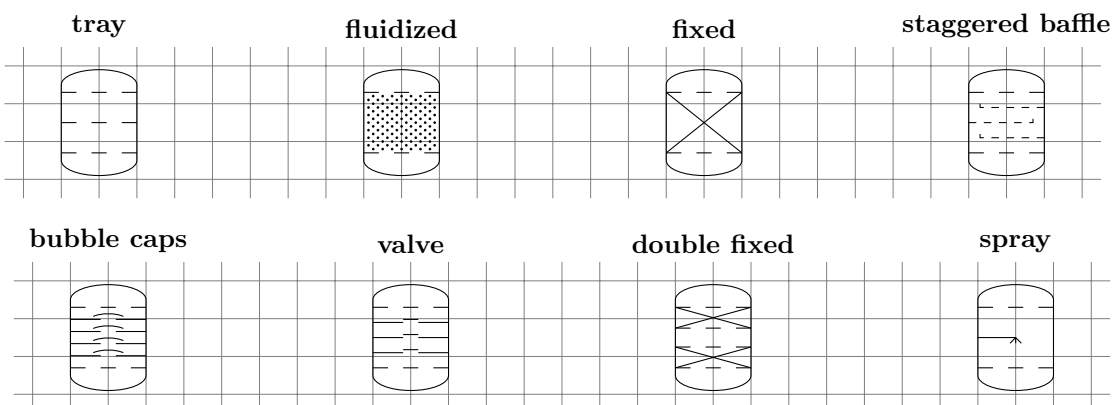

4.5 Pumps

4.5.1 Anchors

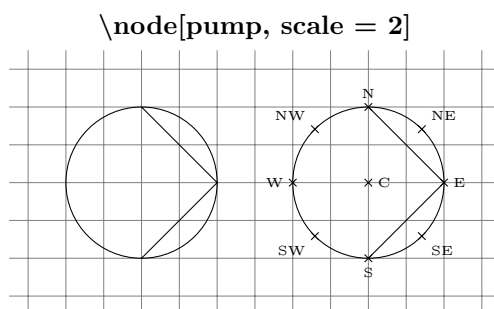

4.5.2 Options

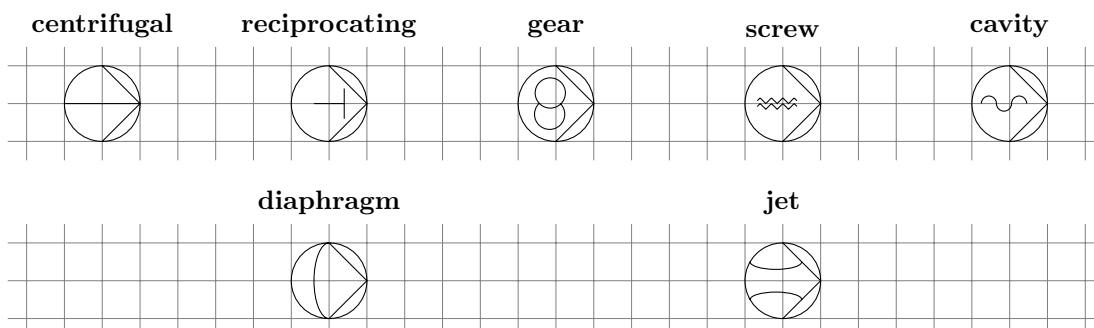

4.6 Compressors

4.6.1 Anchors

`\node[compressor, scale = 2]`

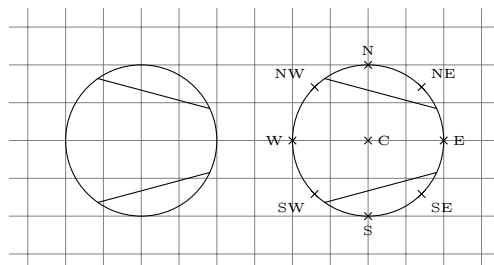

4.6.2 Options

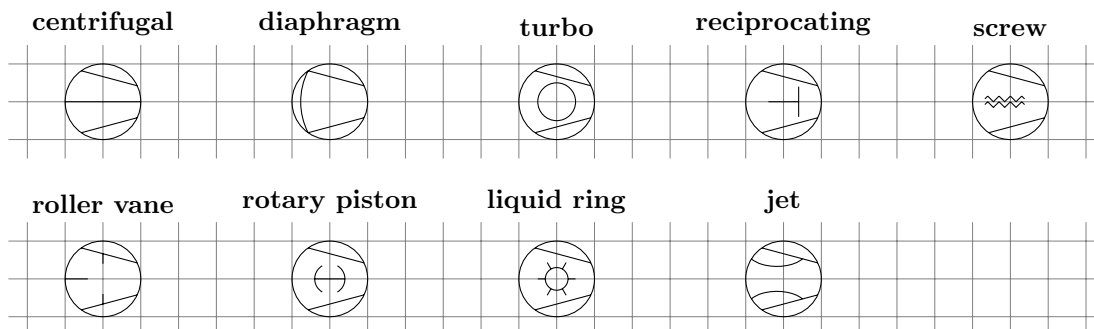

4.7 Separators

4.7.1 Anchors

`\node[column, scale = 2]`

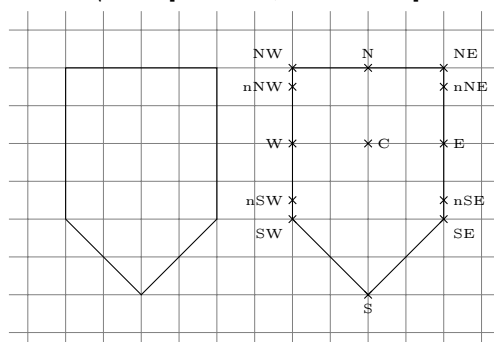

4.7.2 Options

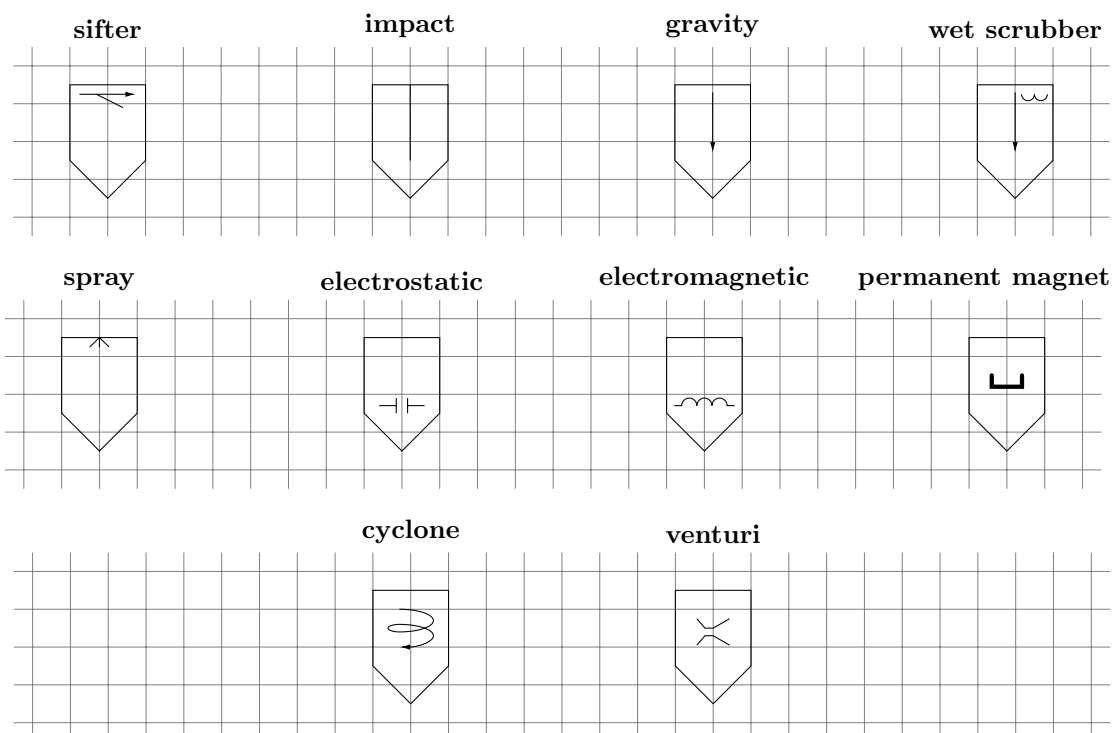

4.8 Tanks

4.8.1 Anchors

The anchors specifically defined for the tank asset are:

Abbreviation	Anchor name	Abbreviation	Anchor name
tNE	tube northeast	tSE	tube southeast
stNE	semi-tube northeast	stSE	semi-tube southeast
ftNE	full-tube northeast	ftSE	full-tube southeast
tNW	tube northwest	tSW	tube southwest
stNW	semi-tube northwest	stSW	semi-tube southwest
ftNW	full-tube northwest	ftSW	full-tube southwest

`\node[tank, scale = 1.5]`

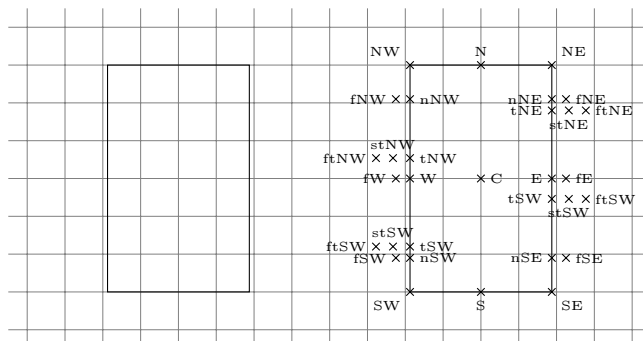

`\node[dished tank, scale = 1.5]`

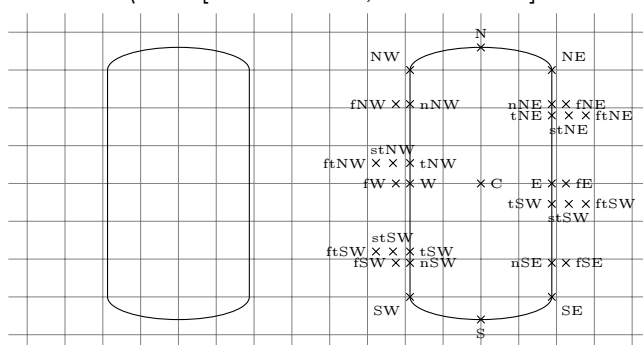

4.8.2 Options

legs

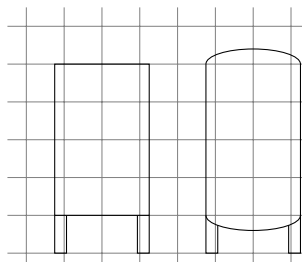

brackets

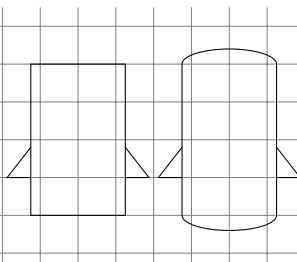

skirt

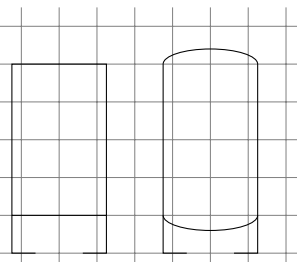

ring

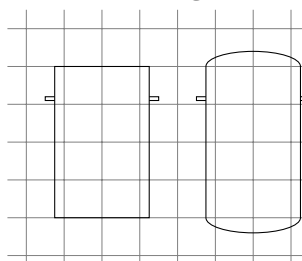

jacket

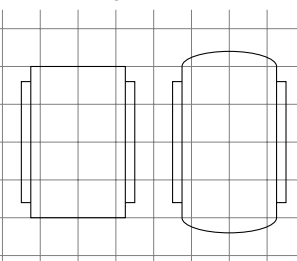

electrical heating

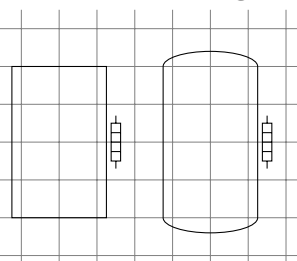

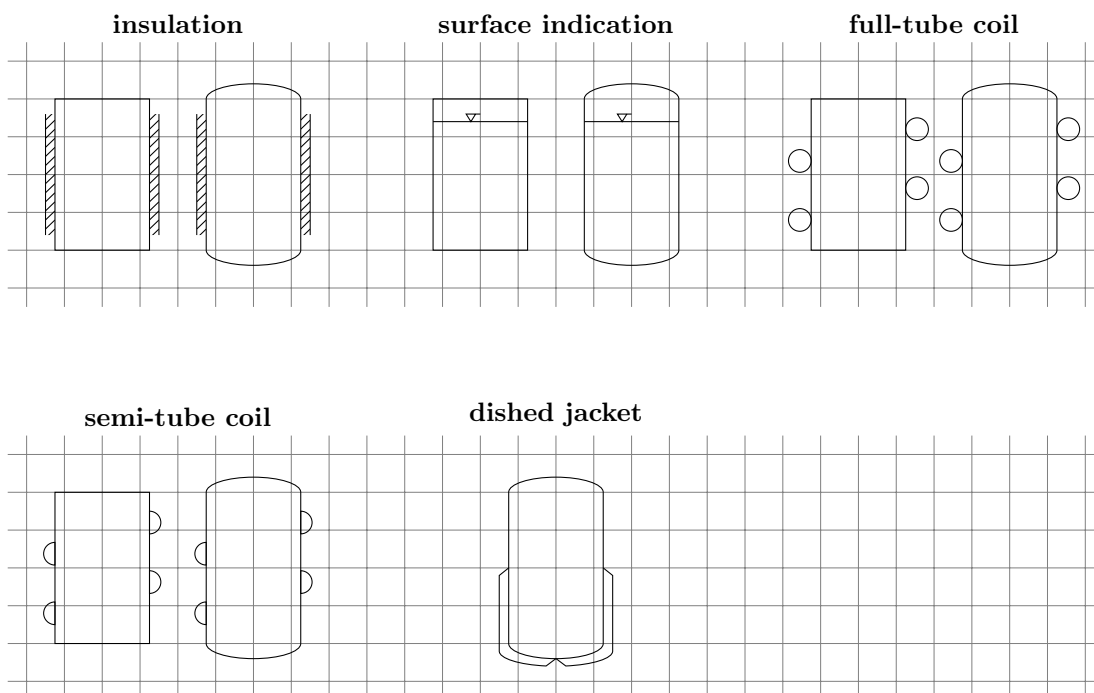

4.9 Crushers

4.9.1 Anchors

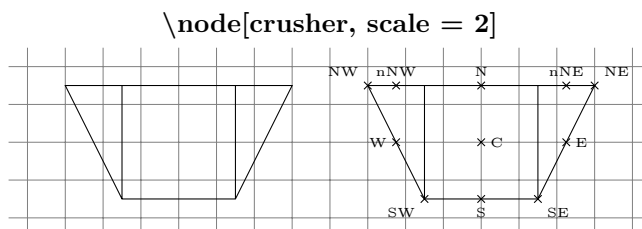

4.9.2 Options

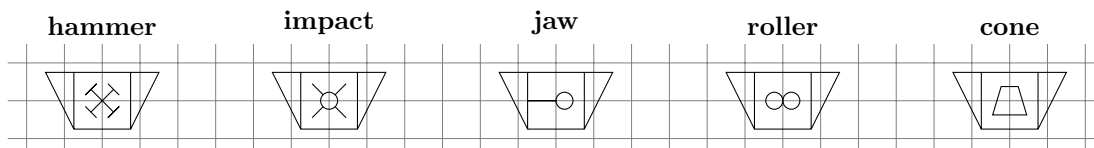

4.10 Mills

4.10.1 Anchors

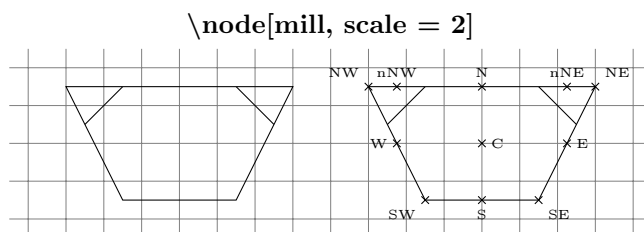

4.10.2 Options

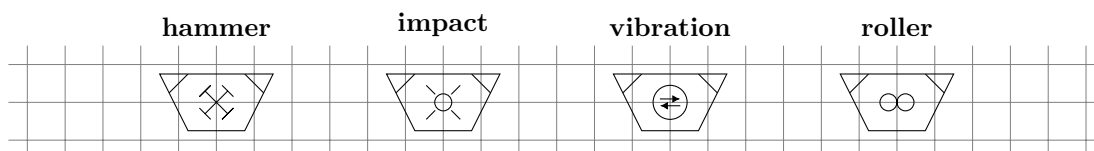

4.11 Press

4.11.1 Anchors

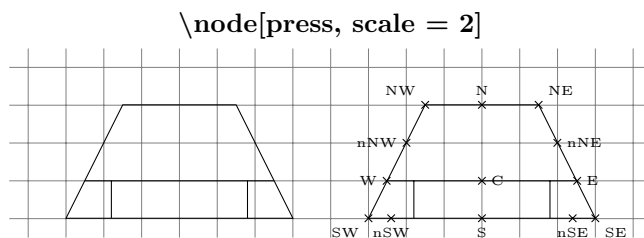

4.11.2 Options

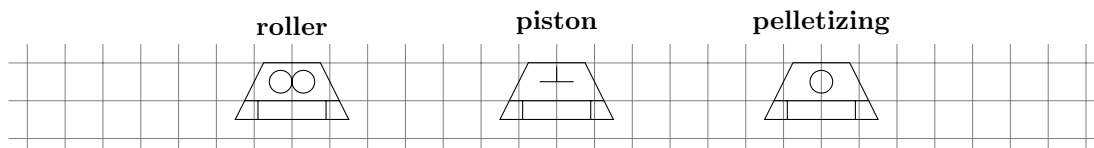

4.12 Cooling towers

4.12.1 Anchors

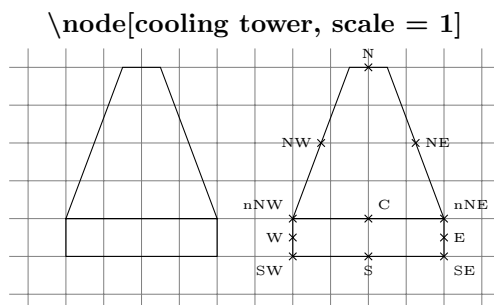

4.12.2 Options

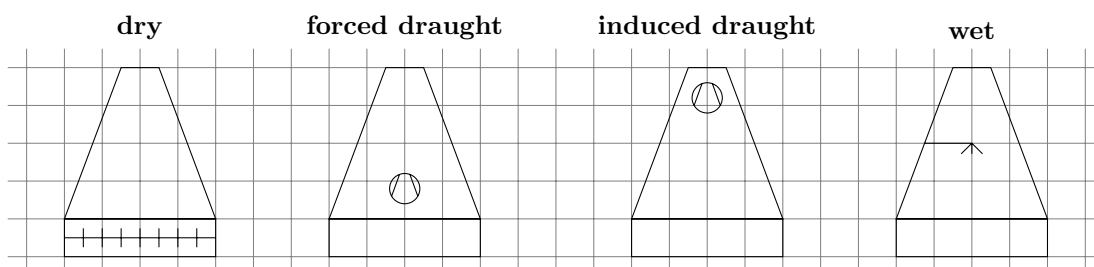

4.13 Driers

4.13.1 Anchors

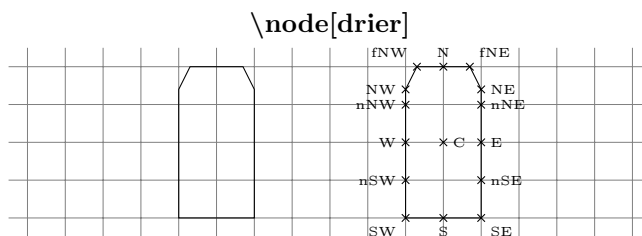

4.13.2 Options

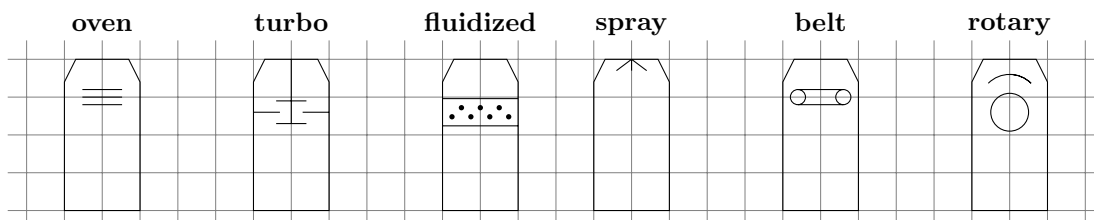

4.14 Gas filters

4.14.1 Anchors

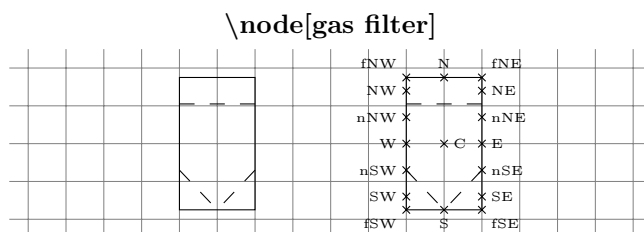

4.14.2 Options

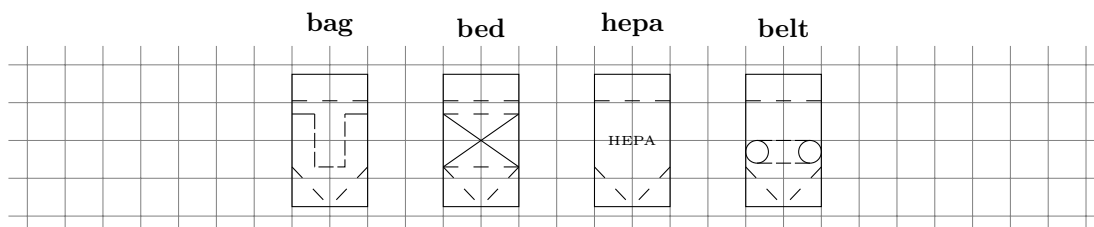

4.15 Liquid filters

4.15.1 Anchors

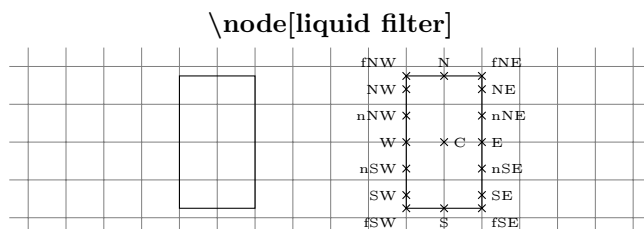

4.15.2 Options

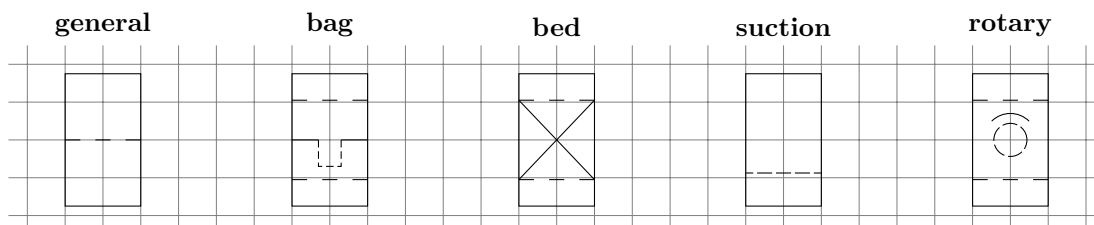

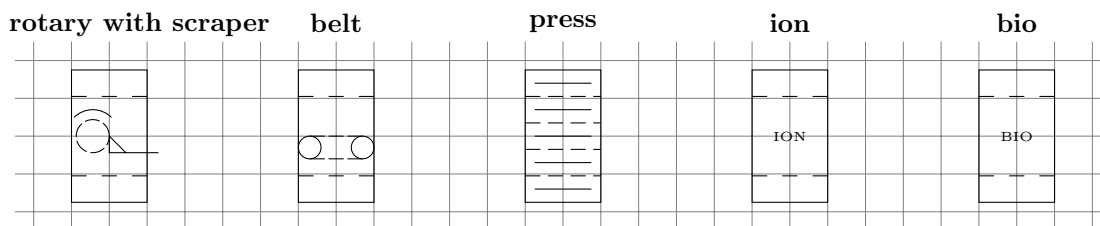

4.16 Fittings

4.16.1 Viewing glass

4.16.1.1 Base

`\node[viewing glass, scale = 4]`

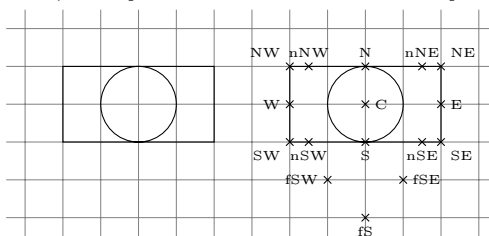

4.16.1.2 Options

lighting

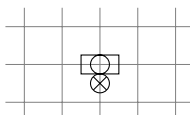

4.16.2 Silencer

`\node[silencer, scale = 4]`

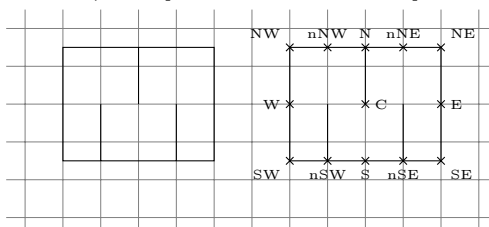

4.16.3 Compensator

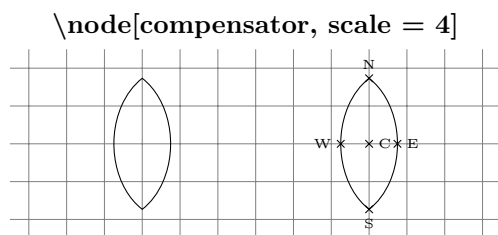

4.16.4 Strainer

4.16.4.1 Base

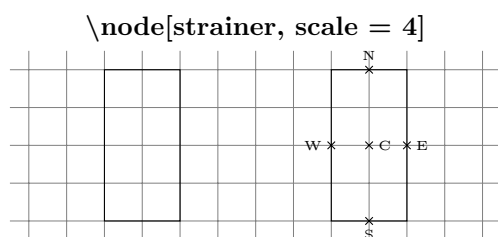

4.16.4.2 Options

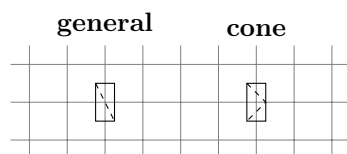

4.16.5 Disc

4.16.5.1 Base

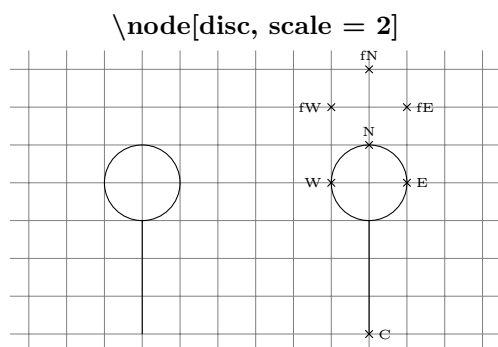

4.16.5.2 Options

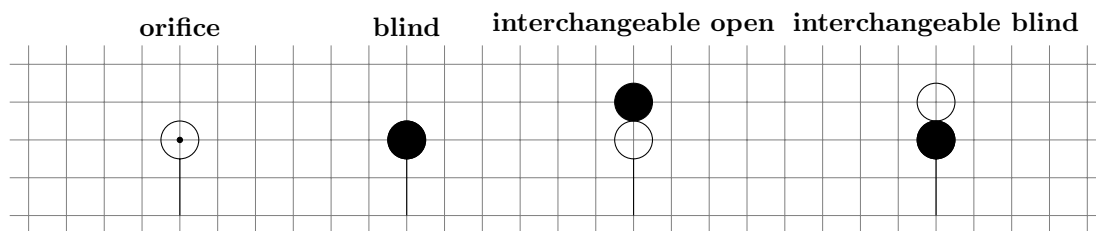

4.16.6 Vent

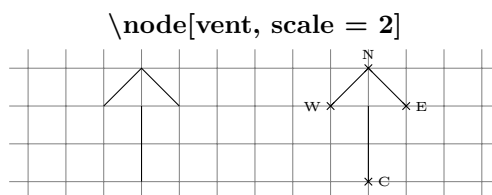

4.16.7 Funnel

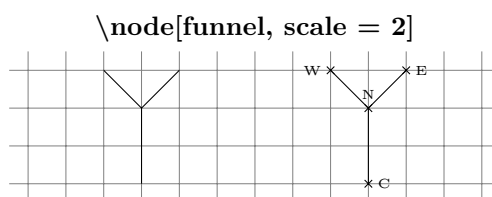

4.16.8 Steam trap

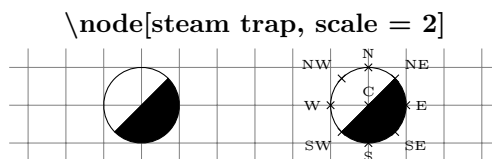

4.16.9 Reducer

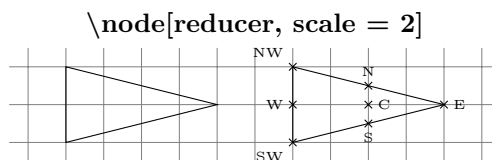

4.16.10 Flange

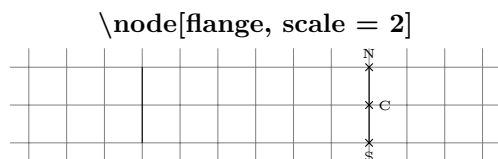

4.16.11 Connection

4.16.11.1 Base

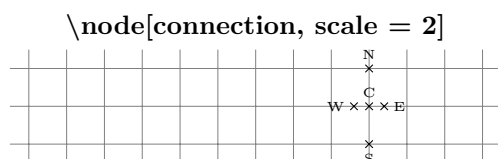

4.16.11.2 Options

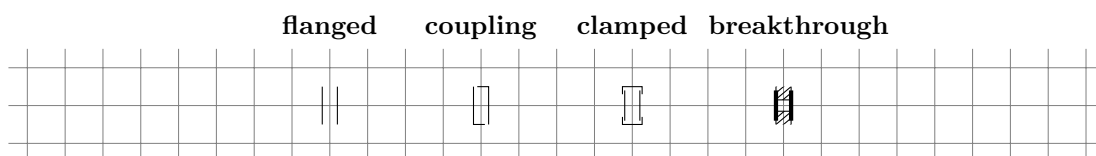

4.16.12 Hose

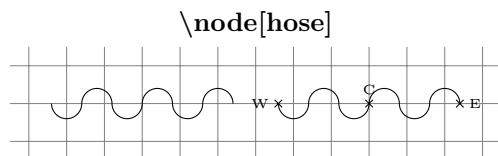

5 Examples

5.1 Distillation column with bubble caps

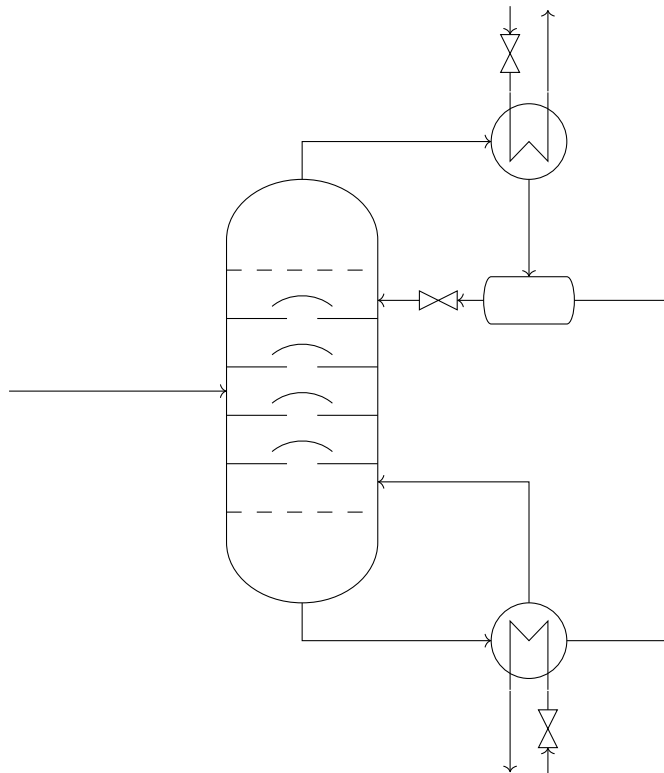

```

\begin{center}
\begin{tikzpicture}
\node[column, /column= bubble caps, yscale = 4, xscale = 2]
(column) at (-2, -2) {};
\node[HE round, /HE round = m, xshift = 3cm, yshift = 0.5cm,
rotate = 90] (condensator) at (column.north) {};
\node[dished tank, xshift = 2cm, rotate = 90, scale = 0.5]
(reflux_drum) at (column.near northeast) {};

\node[HE round, /HE round = m, xshift = 3cm, yshift = -0.5cm,
rotate = 270] (reboiler) at (column.south) {};

\node[valve, /valve = basic, xshift = -0.6cm] (v_reflux) at
(reflux_drum.north) {};
\node[valve, /valve = basic, yshift = 0.5cm, rotate = 90]
(v_condensator) at (condensator.far northeast) {};
\node[valve, /valve = basic, yshift = -0.5cm, rotate = 90]
(v_reboiler) at (reboiler.far northeast) {};

```

```
\node[xshift=-3cm] (start) at (column.west) {};  
\node[xshift = 4cm] (end_light) at (column.near northeast) {};  
\node[xshift = 5cm, yshift = -0.5cm,] (end_heavy) at  
  (column.south) {};  
  
\node[yshift = 0.5cm] (start_condensor) at (v_condensor.east) {};  
\node[yshift = 1.2cm] (end_condensor) at (condensor.far southeast) {};  
  
\node[yshift = -0.5cm] (start_reboiler) at (v_reboiler.west) {};  
\node[yshift = -1.2cm] (end_reboiler) at (reboiler.far southeast) {};  
  
\draw[->] (start) — (column.west);  
  
\draw[->] (column.north) |- (condensor.north);  
\draw[->] (condensor.west) — (reflux_drum.east);  
\draw[->] (reflux_drum.north) — (v_reflux.east);  
\draw[->] (v_reflux.west) — (column.near northeast);  
\draw[->] (reflux_drum.south) — (end_light);  
  
\draw[->] (start_condensor) — (v_condensor.east);  
\draw[-] (v_condensor.west) — (condensor.far northeast);  
\draw[->] (condensor.far southeast) — (end_condensor);  
  
\draw[->] (column.south) |- (reboiler.south);  
\draw[->] (reboiler.west) |- (column.near southeast);  
\draw[->] (reboiler.north) — (end_heavy);  
  
\draw[->] (start_reboiler) — (v_reboiler.west);  
\draw[-] (v_reboiler.east) — (reboiler.far northeast);  
\draw[->] (reboiler.far southeast) — (end_reboiler);  
\end{tikzpicture}  
\end{center}
```

5.2 Tank

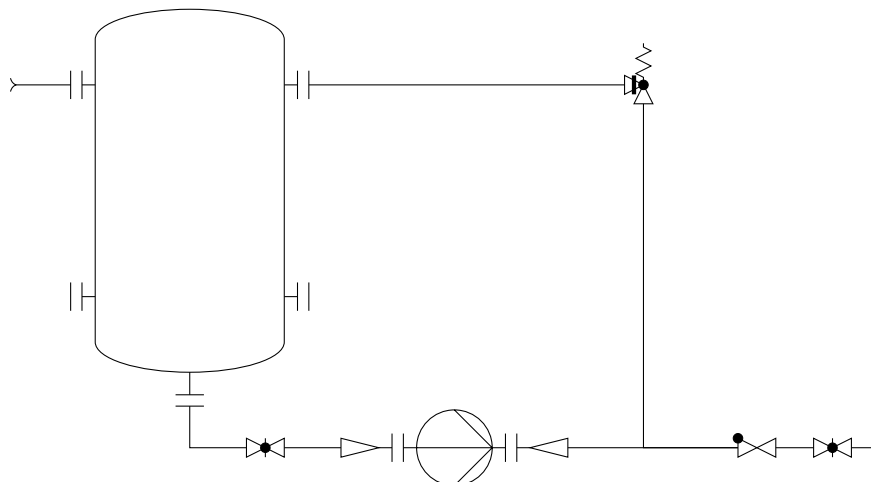

```

\begin{center}
\begin{tikzpicture}

\node[dished tank, scale = 2] (Tank) at (-2, -2) {};
\node[xshift = -1cm](start) at (Tank.far northwest) {};
\node[connection, /connection= flanged, scale = 0.75] (N1)
  at (Tank.far northwest) {};
\node[connection, /connection= flanged, scale = 0.75] (N2)
  at (Tank.far northeast) {};
\node[connection, /connection= flanged, scale = 0.75] (N6)
  at (Tank.far southwest) {};
\node[connection, /connection= flanged, scale = 0.75] (M1)
  at (Tank.far southeast) {};
\node[connection, /connection= flanged, scale = 0.75, yshift = -0.5cm,
  rotate = 90] (N3) at (Tank.south) {};

\node[valve, /valve= safety, /valve= spring loaded, /valve= angle,
  /valve=globe, xshift = 4.5 cm] (P6) at (Tank.far northeast) {};

\node[valve, /valve = butterfly, /valve = basic, xshift = 1cm,
  yshift = -1cm] (V1) at (Tank.south) {};
\node[pump, /pump = centrifugal, xshift = 3.5cm, yshift = -1cm] (P001)
  at (Tank.south) {};

\node[reducer, xshift = -0.75cm, scale = 0.5] (R1) at (P001.west) {};
\node[connection, /connection= flanged, xshift = -0.25cm,
  scale = 0.75] (F1) at (P001.west) {};
\node[reducer, xshift = 0.75cm, scale = 0.5, rotate = 180] (R2)
  at (P001.east) {};
\node[connection, /connection= flanged, xshift = 0.25cm, scale = 0.75]
  (F2) at (P001.east) {};

```

```
\node[valve, /valve=check, /valve=basic, xshift=3cm] (V2)
  at (R2.east) {};
\node[valve, /valve=butterfly, /valve=basic, xshift=4cm] (V3)
  at (R2.east) {};

\node[xshift = 1cm] (end) at (V3.west) {};

\draw[>-] (start) — (N1.west);
\draw[-] (N1.east) — (Tank.near northwest);
\draw[-] (N6.east) — (Tank.near southwest);
\draw[-] (M1.west) — (Tank.near southeast);

\draw[-] (Tank.near northeast) — (N2.west);
\draw[-] (N2.east) — (P6.west);
\draw[-] (P6.far south) |- (V2.west);

\draw[-] (Tank.south) — (N3.east);
\draw[-] (N3.west) |- (V1.west);
\draw[-] (V1.east) — (R1.west);
\draw[-] (R1.east) — (F1.west);
\draw[-] (F1.east) — (P001.west);
\draw[-] (P001.east) — (F2.west);
\draw[-] (F2.east) — (R2.east);
\draw[-] (R2.west) — (V2.west);
\draw[-] (V2.east) — (V3.west);
\draw[->] (V3.east) — (end);

\end{tikzpicture}
\end{center}
```